

MC10-400

PERFORMANCE & DIMENSIONS

Inlet (FNPT)	1.5"	HP	1
Outlet (MNPT)	1.5"	Voltage	115/230
Max Flow (GPM)	95	Phase	1
Max Head	59'	Amps	12.4/6.2

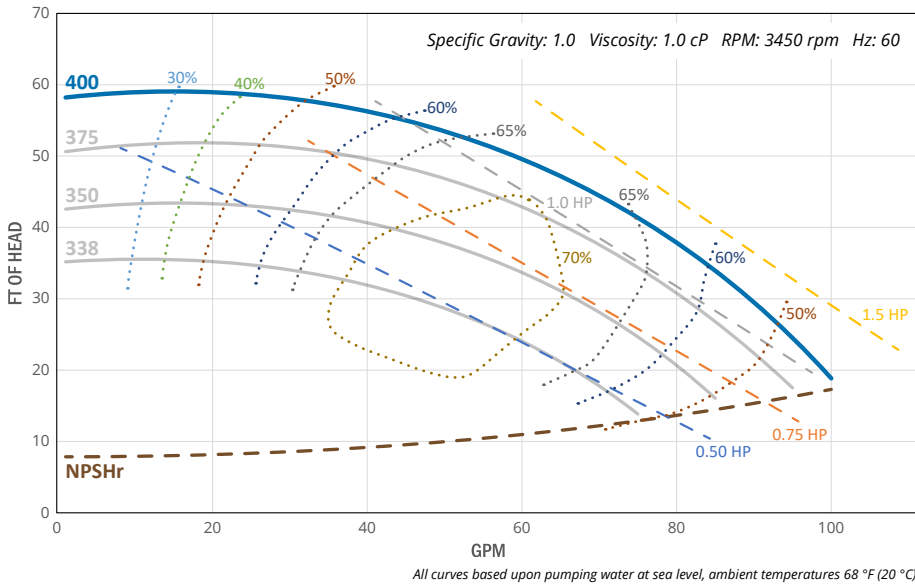

DIMENSIONS

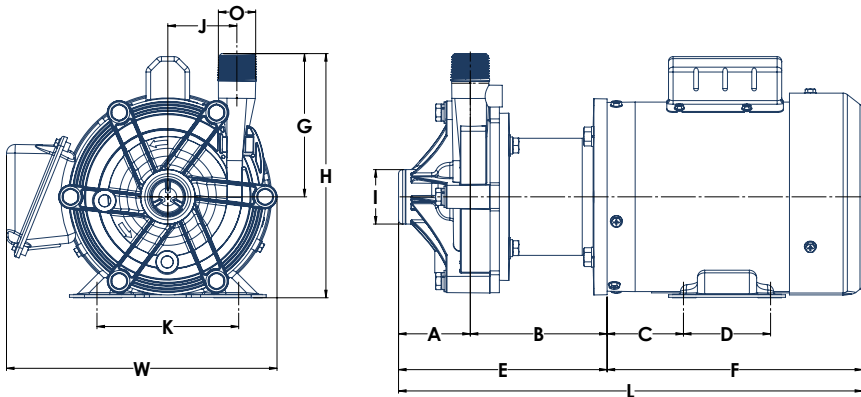

Diagram is for illustrative purposes. Dimensions are for reference only. Pump configurations may vary by model. Do not use for construction purposes.

I = Suction	O = Discharge	L/H/W = Envelope Dimensions
-------------	---------------	-----------------------------

MOTOR FRAME	A	B	C	D	E	F	G	H	I (NPT) Suction	J	K	L	O (NPT) Discharge	W
NEMA 56C	2.35	4.83	2.63	3	7.18	8.8	4.93	8.41	1.5	2.6	4.88	15.98	1.5	9.13

MOTOR DATA

RPM	ENCL	RATING	FRAME	S.F.	DUTY	FLA	INS CLASS	EFF	INVERTER READY	CONSTRUCTION
3450	TEFC	IP55	56C	1.15	Cont	12.4/6.2	F	64	Y	Steel painted

LIQUID END MATERIALS OF CONSTRUCTION

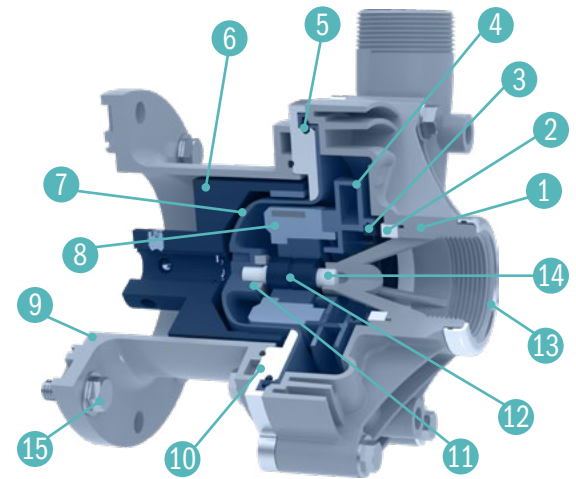

Diagram is for illustrative purposes. Pump configurations may vary by model.

DESCRIPTION	STANDARD
1 Front Pump Housing	GFRPP
2 Front Thrust Ring	Alumina ceramic
3 Impeller Thrust Ring	PTFE
4 Impeller	GFRPP
5 O-Rings	FKM
6 Outer Drive Magnet	Nd/epoxy-coated steel
7 Containment Shell	GFRPP
8 Inner Drive Magnet	Neodymium/PP
9 Motor Bracket	GFRPP
10 Pump Housing Support	316L stainless steel
11 Rear Thrust Ring	Silicon carbide
12 Bushing	Carbon graphite
13 Inlet Ring	316L stainless steel
14 Shaft	Alumina ceramic
15 Hardware	316 stainless steel

Additional materials of construction are available. Please refer to factory.



Scan for complete MC Series specifications, performance curves, and documentation.